

8 7 6 5 4 3 2 1

48" x 96" FREESTANDING IGNITER LIGHTBOX IG48X96

**PLEASE REFER TO LAST PAGE OF
MANUAL FOR SEG INSTRUCTIONS**

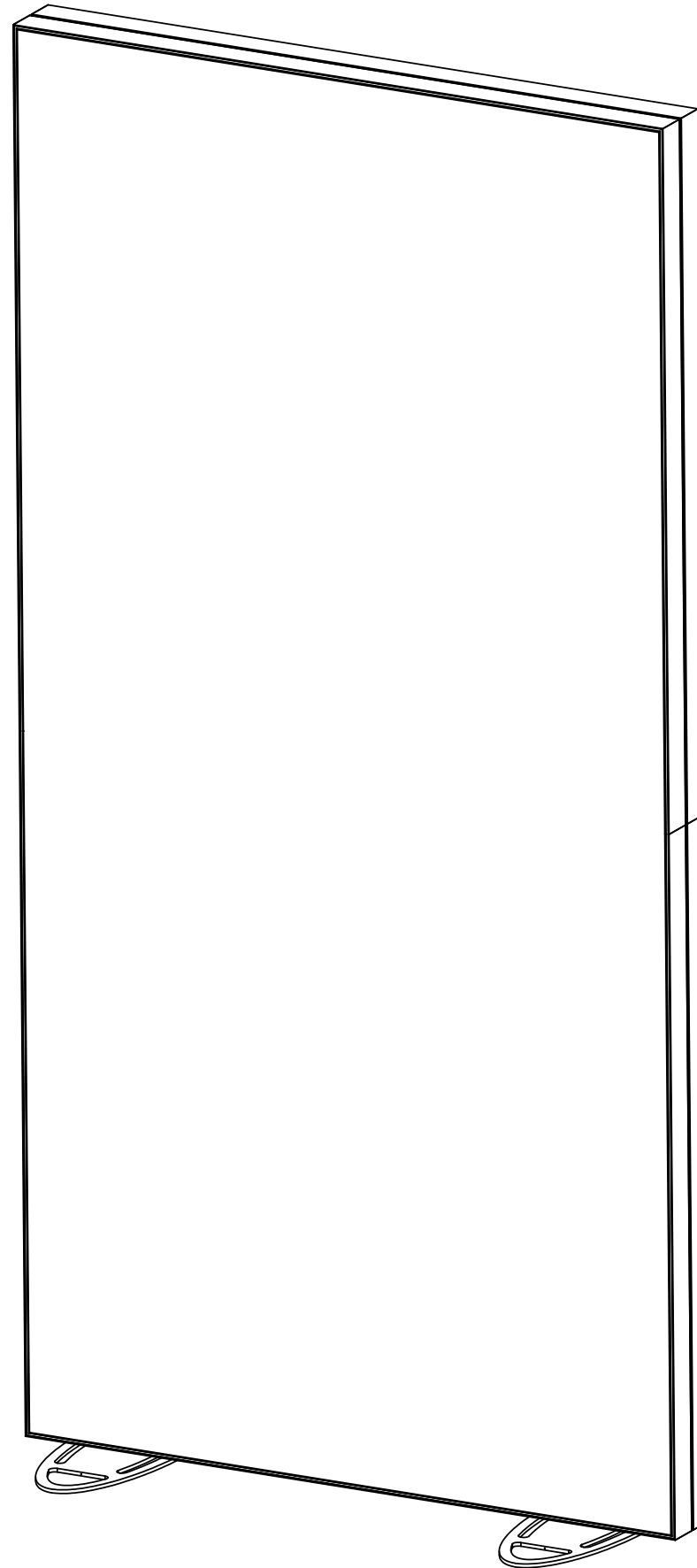

FRONT VIEW WITH GRAPHIC

SET-UP MANUAL



FINISH:	THIRD ANGLE PROJECTION	PROPERTY: THIS DOCUMENT AND DATA DISCLOSED HEREIN OR HEREWITH IS NOT TO BE REPRODUCED, USED, OR DISCLOSED IN WHOLE OR IN PART TO ANYONE WITHOUT PERMISSION OF NIEDO GROUP, INC.
MATERIAL:	 NIEDO GROUP, INC.	5465 SW WESTERN AVE. BEAVERTON, OR 97005
DIMENSIONS ARE IN MILLIMETERS	48" x 96" FREESTANDING IGNITER LIGHTBOX SETUP INSTRUCTION	
TOLERANCES UNLESS OTHERWISE SPECIFIED	REV: B	REV: -01
	SCALE: NA	DO NOT SCALE DRAWING SHEET 1

8 7 6 5 4 3 2 1

48" x 96" FREESTANDING IGNITER LIGHTBOX IG48X96

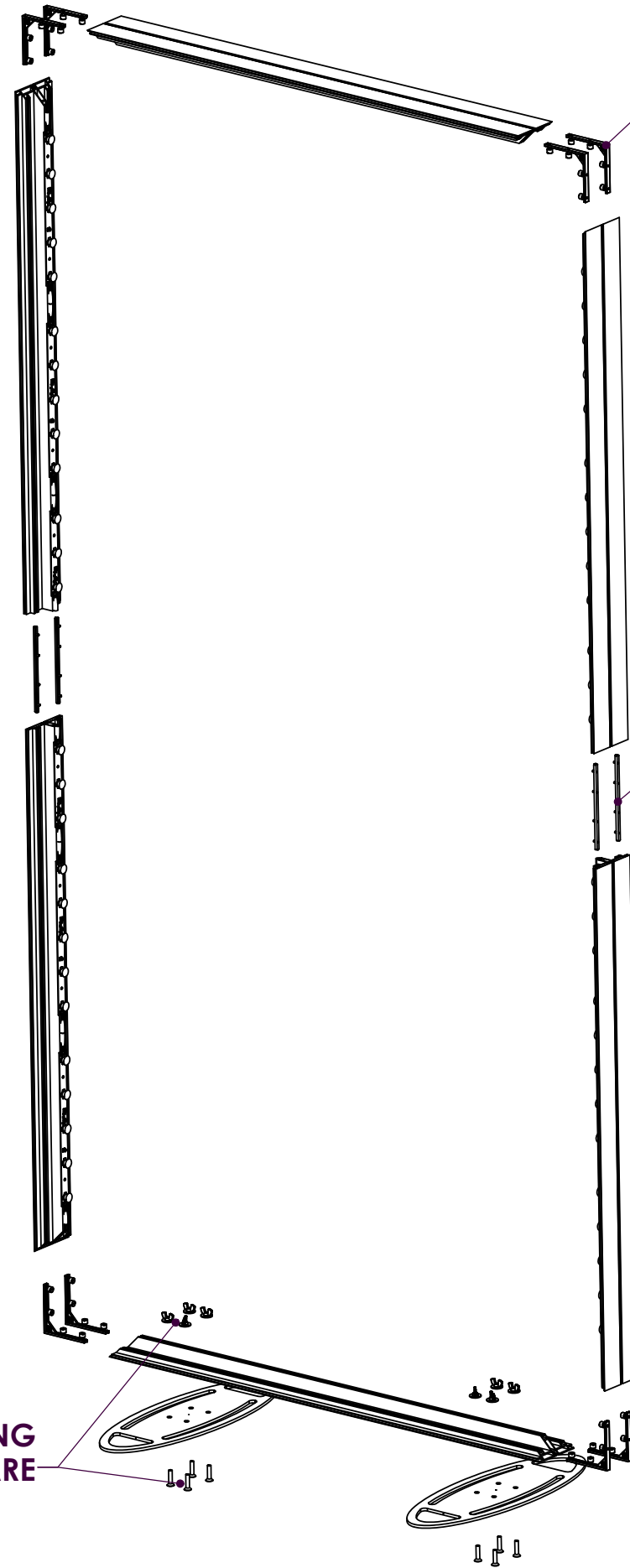
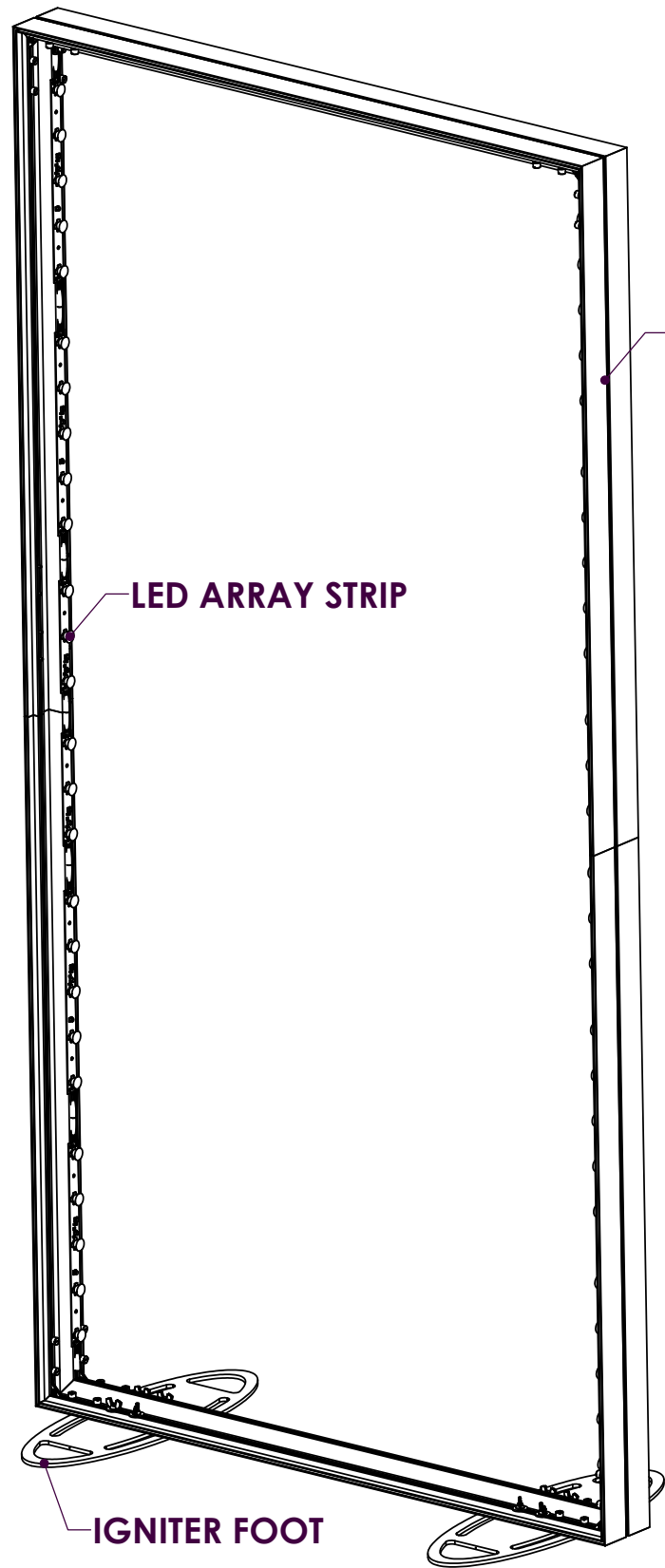

FINISH:		THIRD ANGLE PROJECTION		PROPERTY: THIS DOCUMENT AND DATA DISCLOSED HEREIN OR HEREWITH IS NOT TO BE REPRODUCED, USED, OR DISCLOSED IN WHOLE OR IN PART TO ANYONE WITHOUT PERMISSION OF NIEDO GROUP, INC.	
MATERIAL:		NIEDO GROUP, INC.		5465 SW WESTERN AVE. BEAVERTON, OR 97005	
DIMENSIONS ARE IN MILLIMETERS		48" x 96" FREESTANDING IGNITER LIGHTBOX SETUP INSTRUCTION			
TOLERANCES UNLESS OTHERWISE SPECIFIED		REV: B		REV: -01	
SCALE: NA		DO NOT SCALE DRAWING		SHEET 1	

48" x 96" FREESTANDING IGNITER LIGHTBOX IG48X96

FRAME ASSEMBLY DETAILS

1. WITH FRAME FLAT ON THE FLOOR ASSEMBLE FRAME SIDES WITH JOINT INSERTS IN OUTSIDE CHANNELS OF FRAME AS SHOWN. TIGHTEN SETSCREWS.

2. ASSEMBLE CORNERS USING CORNER BRACKETS INSERTED INTO OUTSIDE CHANNELS OF FRAME AS SHOWN. FINGER TIGHTEN THUMB SCREWS ONLY.

3. ASSEMBLE FEET TO FRAME WITH SCREWS AND HARDWARE PROVIDED. FINGER TIGHTEN WING NUTS. STAND FRAME UP TO CONTINUE.

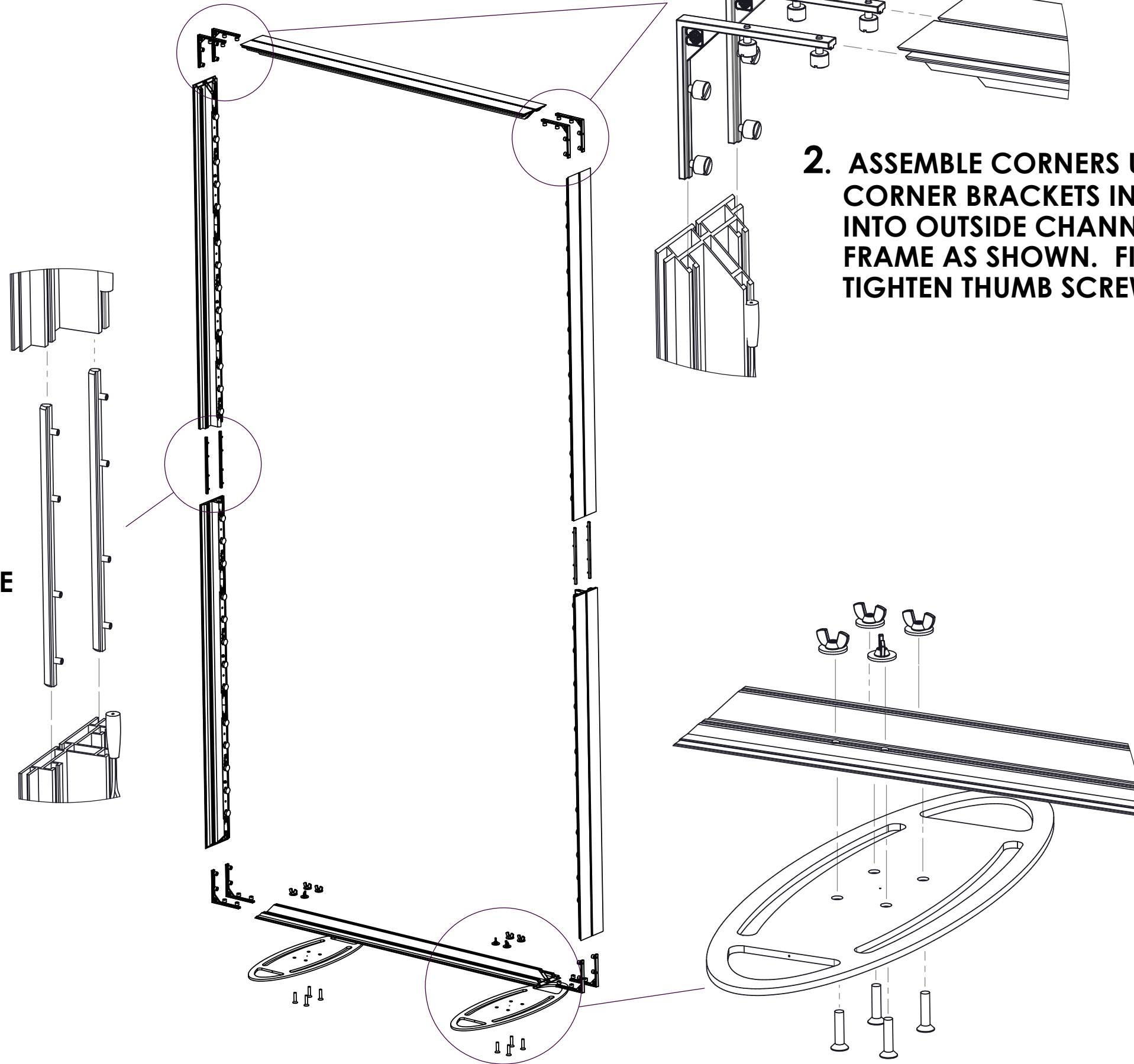

FINISH:	THIRD ANGLE PROJECTION	PROPERTY: THIS DOCUMENT AND DATA DISCLOSED HEREIN OR HEREWITH IS NOT TO BE REPRODUCED, USED, OR DISCLOSED IN WHOLE OR IN PART TO ANYONE WITHOUT PERMISSION OF NIEDO GROUP, INC.
MATERIAL:		
DIMENSIONS ARE IN MILLIMETERS	NIEDO GROUP, INC. 5465 SW WESTERN AVE. BEAVERTON, OR 97005	
TOLERANCES UNLESS OTHERWISE SPECIFIED	48" x 96" FREESTANDING IGNITER LIGHTBOX SETUP INSTRUCTION	
REV B	DWG. NO.	REV -01
SCALE: NA	DO NOT SCALE DRAWING	SHEET 1

48" x 96" FREESTANDING IGNITER LIGHTBOX IG48X96

LED ARRAY INTERCONNECT DETAIL

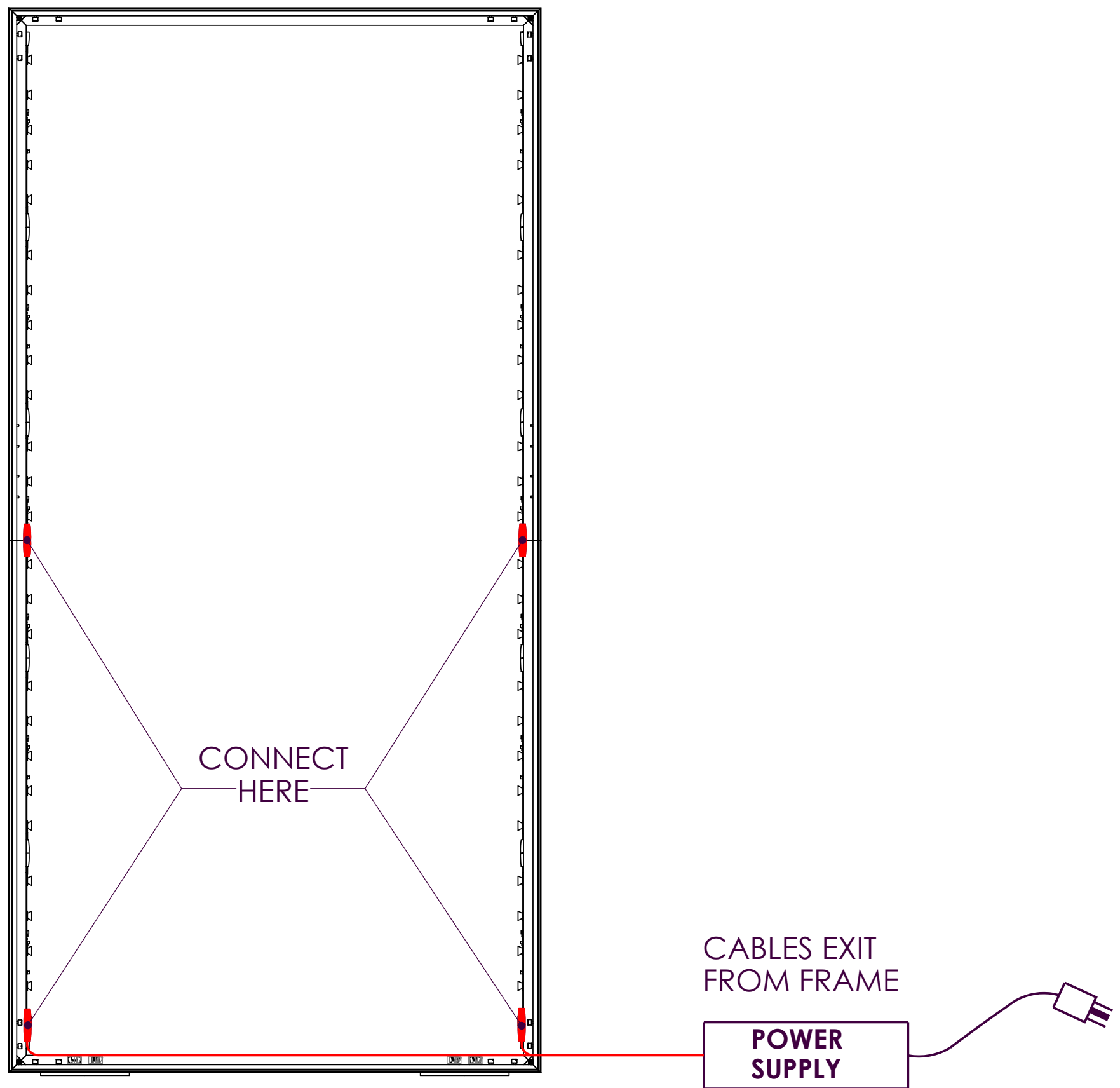

FINISH:	THIRD ANGLE PROJECTION	PROPERTY: THIS DOCUMENT AND DATA DISCLOSED HEREIN OR HEREWITH IS NOT TO BE REPRODUCED, USED, OR DISCLOSED IN WHOLE OR IN PART TO ANYONE WITHOUT PERMISSION OF NIEDO GROUP, INC.
MATERIAL:	 NIEDO GROUP, INC. 5465 SW WESTERN AVE. BEAVERTON, OR 97005	
DIMENSIONS ARE IN MILLIMETERS	48" x 96" FREESTANDING IGNITER LIGHTBOX SETUP INSTRUCTION	
TOLERANCES UNLESS OTHERWISE SPECIFIED		
SIZE: B	DWG. NO.:	REV: -01
SCALE: NA	DO NOT SCALE DRAWING	SHEET 1

Silicone Edge Graphics (SEG)

Installation Instructions into hardware

What are Silicone Edge Graphics (SEG)?

SEG are dye-sublimation fabric graphics with silicone strips sewn along the underside of the fabric's edge. SEG frames have grooves along their perimeter designed to snugly hold the silicone strips so the fabric can be stretched across the frame for a drum-tight fit.



We recommend laying the frame on the floor, then draping the fabric graphic on top.

The following procedure ensures the silicone edge will be placed evenly over the entire frame and NOT STRETCH or GROW at the corners. Once all the edges have been secured, you should have a taut fit with a smooth flat finish.

1: With Clean Hands,

Press SEG silicone edge first, into the corners of the frame.

INCORRECT WAY

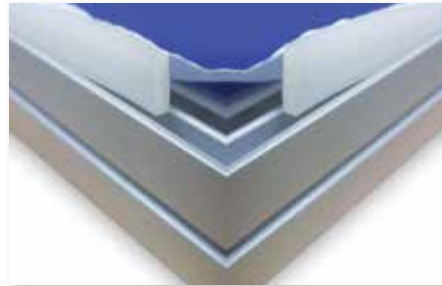

CORRECT WAY

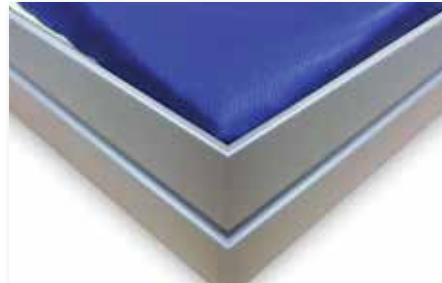

2: Working in Centers.

Go back and press the silicone edge into the center - on each side of the frame.

EXAMPLE: A 20"x20" fabric/frame would be pressed in 8 locations.

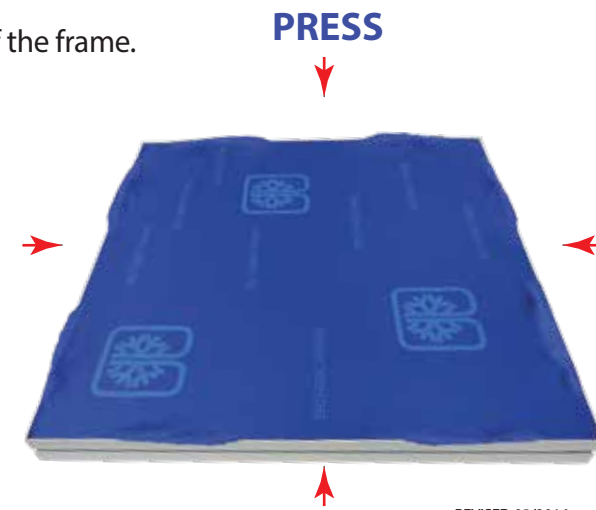

REVISED 03/2016

Cont'd.

3: Working in Centers again,

Go back and press the silicone edge once again on each side previous center, on all 4 sides.

Repeat this process, (WORKING IN CENTERS) until the SEG fabric's edge is pressed approximately every 6 inches apart.

EXAMPLE: A 8' x 8' frame (using this procedure) will have been pressed/tucked 15 times (not including corners) on each side of the frame.

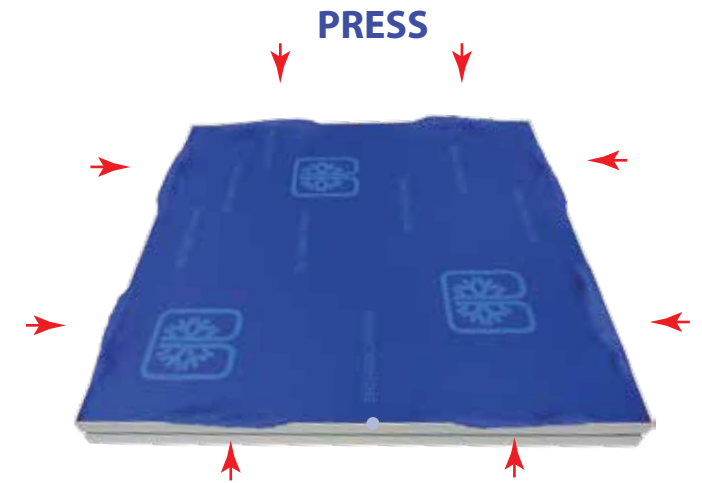
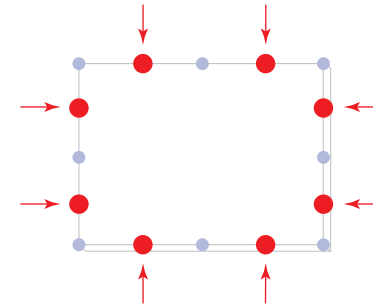

4: After all has been pressed into your frame using

this procedure, lightly tap your forefinger to smooth fabric between the tucks.



CARE INSTRUCTIONS

Due to the fine quality, smoothness and weave of the fabric, great care must be taken to extend the life of your SEG fabric graphics.

We recommend very loosely folding your graphic, making sure there are no hard creases or folds or that the fabric doesn't catch on sharp objects.

Store in a clean bag.
A plastic bag or pillow case is ideal.
Graphics can also be spot cleaned with a damp cloth.

To wash entire graphic, use a commercial size front loading washing machine on gentle cycle with cool water. Do NOT dry clean.

You can also gently iron the back side using the Polyester setting of your iron.



REVISED 04/2016